

Description

The Direct Current Thermal-Link Alloy Type (DC-ATCO) is defined as a non-resettable protective device functioning only once. It is widely used for over-temperature protection of electrical equipment and electric vehicles. The DC-ATCO primarily consists of Electrode Lead, Case, a low melting point Thermal Element, Flux Resin and Sealant. Normally, the Thermal Element is joined to the two lead wires. When the temperature reaches the fusing temperature of the Direct Current Thermal-Link (Alloy Type), the Thermal Element melts and quickly retracts to the two lead wire ends with the aid of the flux resin, disconnecting the circuit completely.

The SETsafe | SETfuse Direct Current Thermal-Link (Alloy Type) is classified into Axial and Radial shapes, with a Rated Functioning Temperature ranging from 102 °C to 136 °C, Rated Current ranging from 25 A to 80 A, Rated Voltage: 100 VDC, 125 VAC. It is also RoHS and REACH compliant.

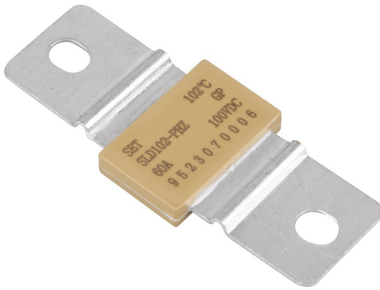

Marking

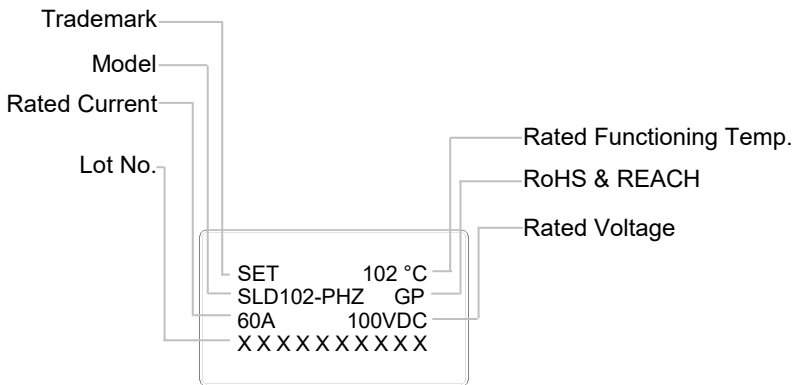

Structure Diagram

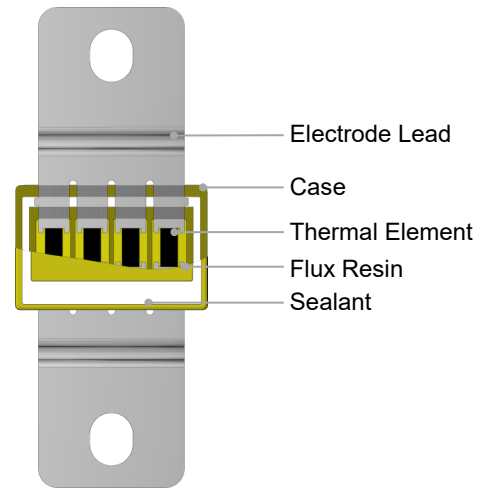

Product Schematic

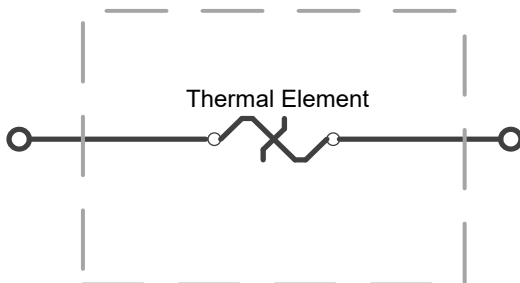

Features

- High Accuracy of Functioning Temp.
- Non-Resettable
- RoHS & REACH Compliant
- DC 25 A / 30 A / 40 A / 50 A / 60 A / 80 A

Applications

- EV Battery Modules
- PTC Heaters
- Power Supplies

Customization

- Rated Functioning Temp.
- The Shape of Electrode Lead

DC-ATCO

Direct Current Thermal-Link (Alloy Type)

SLx Series

Part Number System

SLD102 - P H Z

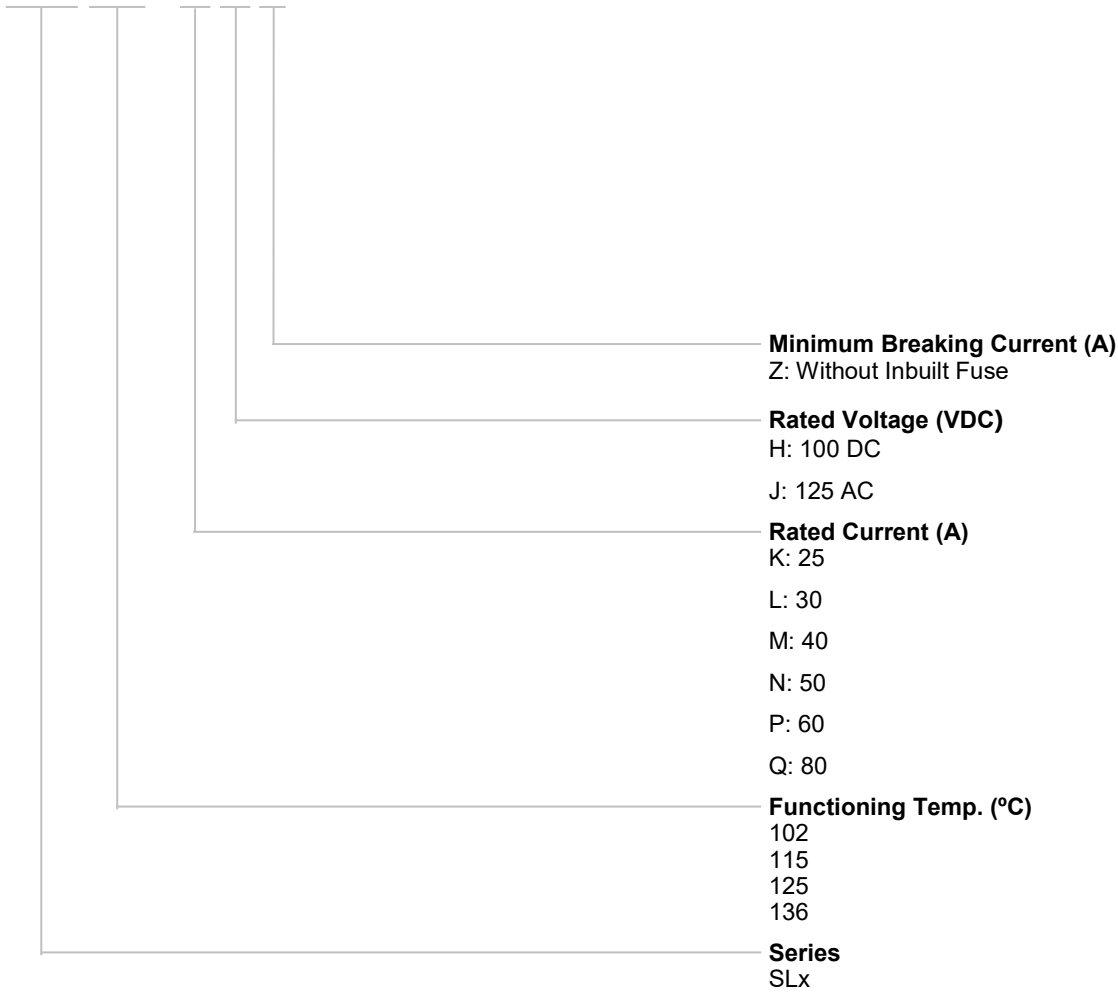

DC-ATCO

Direct Current Thermal-Link (Alloy Type)

SLx Series

Dimensions (Unit: mm)

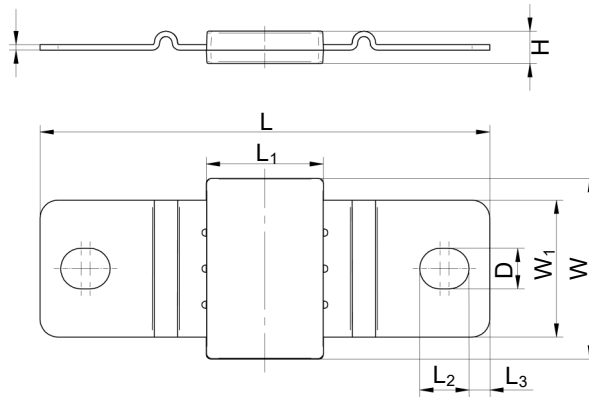

L	L ₁	L ₂	L ₃	W	W ₁	D	H	t
50.0 ± 1.0	13.0 ± 0.5	5.5 ± 0.5	2.3 ± 0.2	20.0 ± 0.5	15.2 ± 0.2	4.5 ± 0.2	3.6 ± 0.5	0.60 ± 0.05

Specifications

I_f : 25 A

Rated Functioning Temp. (T_f) °C

	Model	I_f	U_r	Rated Functioning Temp.	T_h	T_m	RoHS REACH
		(A)	(V)	(°C)	(°C)	(°C)	
136	SLA136-KHZ	25	DC 100	131 ± 3	91	180	●
	SLA136-KJZ		AC 125				●
125	SLA125-KHZ	25	DC 100	122 ± 3	80	180	●
	SLA125-KJZ		AC 125				●
115	SLA115-KHZ	25	DC 100	112 ± 3	70	180	●
	SLA115-KJZ		AC 125				●
102	SLA102-KHZ	25	DC 100	99 ⁺⁵ / ₋₃	57	180	●
	SLA102-KJZ		AC 125				●

I_f : 30 A

Rated Functioning Temp. (T_f) °C

	Model	I_f	U_r	Rated Functioning Temp.	T_h	T_m	RoHS REACH
		(A)	(V)	(°C)	(°C)	(°C)	
136	SLB136-LHZ	30	DC 100	131 ± 3	91	180	●
	SLB136-LJZ		AC 125				●
125	SLB125-LHZ	30	DC 100	122 ± 3	80	180	●
	SLB125-LJZ		AC 125				●
115	SLB115-LHZ	30	DC 100	112 ± 3	70	180	●
	SLB115-LJZ		AC 125				●
102	SLB102-LHZ	30	DC 100	99 ⁺⁵ / ₋₃	57	180	●
	SLB102-LJZ		AC 125				●

Note:
1. RoHS & REACH Comply.

Specifications

I_f : 40 A

Rated Functioning Temp. (T_f) °C

	Model	I_f	U_f	Rated Functioning Temp.	T_h	T_m	RoHS REACH
		(A)	(V)	(°C)	(°C)	(°C)	
136	SLC136-MHZ	40	DC 100	131 ± 3	91	180	●
	SLC136-MJZ		AC 125				●
125	SLC125-MHZ	40	DC 100	122 ± 3	85	180	●
	SLC125-MJZ		AC 125				●
115	SLC115-MHZ	40	DC 100	112 ± 3	70	180	●
	SLC115-MJZ		AC 125				●
102	SLC102-MHZ	40	DC 100	99 $\begin{smallmatrix} +5 \\ -3 \end{smallmatrix}$	57	180	●
	SLC102-MJZ		AC 125				●

I_f : 50 A

Rated Functioning Temp. (T_f) °C

	Model	I_f	U_f	Rated Functioning Temp.	T_h	T_m	RoHS REACH
		(A)	(V)	(°C)	(°C)	(°C)	
136	SL136-NHZ	50	DC 100	131 ± 3	91	180	●
	SL136-NJZ		AC 125				●
125	SL125-NHZ	50	DC 100	122 ± 3	80	180	●
	SL125-NJZ		AC 125				●
115	SL115-NHZ	50	DC 100	112 ± 3	70	180	●
	SL115-NJZ		AC 125				●
102	SL102-NHZ	50	DC 100	99 $\begin{smallmatrix} +5 \\ -3 \end{smallmatrix}$	60	180	●
	SL102-NJZ		AC 125				●

Note:
1. RoHS & REACH Comply.

Specifications

I_f : 60 A

Rated Functioning Temp. (T_f) °C

	Model	I_f	U_f	Rated Functioning Temp.	T_h	T_m	RoHS REACH
		(A)	(V)	(°C)	(°C)	(°C)	
136	SLD136-PHZ	60	DC 100	131 ± 3	91	180	●
	SLD136-PJZ		AC 125				●
125	SLD125-PHZ	60	DC 100	122 ± 3	80	180	●
	SLD125-PJZ		AC 125				●
115	SLD115-PHZ	60	DC 100	112 ± 3	70	180	●
	SLD115-PJZ		AC 125				●
102	SLD102-PHZ	60	DC 100	99 ⁺⁵ / ₋₃	57	180	●
	SLD102-PJZ		AC 125				●

I_f : 80 A

Rated Functioning Temp. (T_f) °C

	Model	I_f	U_f	Rated Functioning Temp.	T_h	T_m	RoHS REACH
		(A)	(V)	(°C)	(°C)	(°C)	
136	SLE136-QHZ	80	DC 100	131 ± 3	91	180	●
	SLE136-QJZ		AC 125				●
125	SLE125-QHZ	80	DC 100	122 ± 3	80	180	●
	SLE125-QJZ		AC 125				●
115	SLE115-QHZ	80	DC 100	112 ± 3	70	180	●
	SLE115-QJZ		AC 125				●
102	SLE102-QHZ	80	DC 100	99 ⁺⁵ / ₋₃	57	180	●
	SLE102-QJZ		AC 125				●

Note:
1. RoHS & REACH Comply.

Temp.-Time Curve

The functioning temperature time curve of Alloy Thermal-Link in different Temp. oil bath (For reference only).

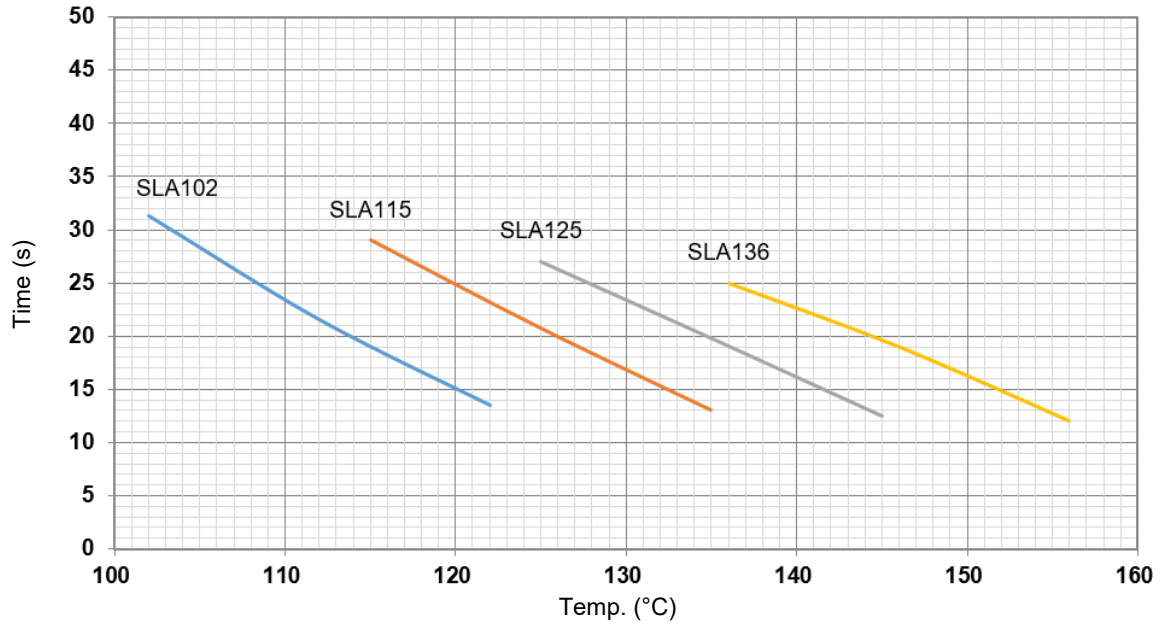

Current-Time Curve

This is an illustrated curve, describing the opening time at Multi-times rated current in the condition of the room Temp. 25 °C (For reference only).

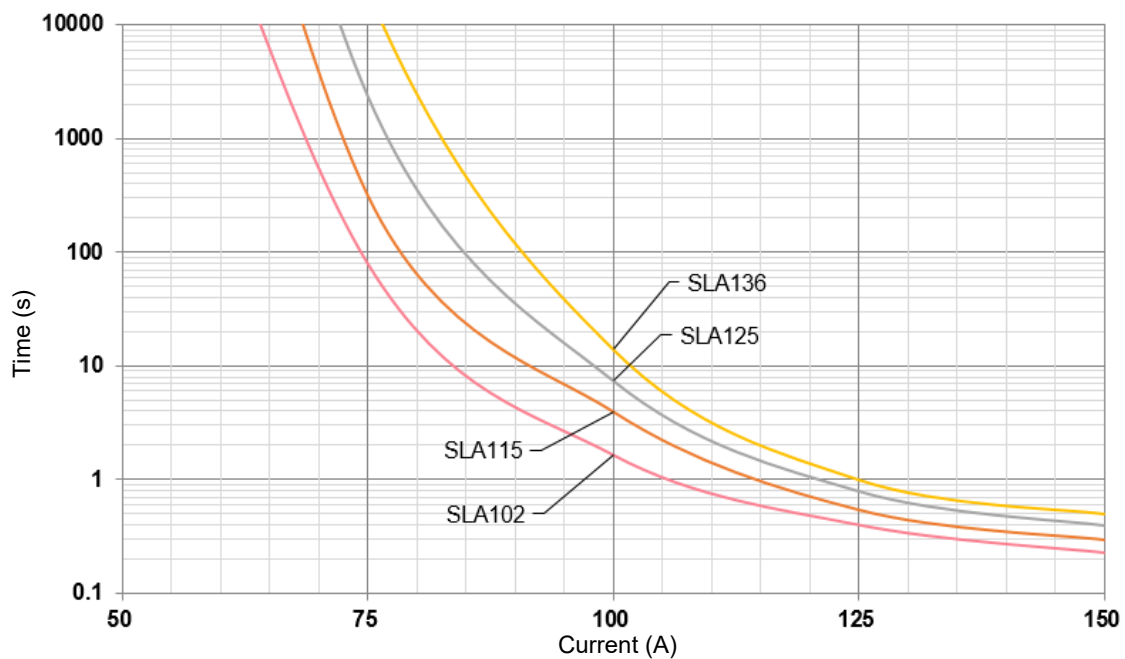

Temp.-Time Curve

The functioning temperature time curve of Alloy Thermal-Link in different Temp. oil bath (For reference only).

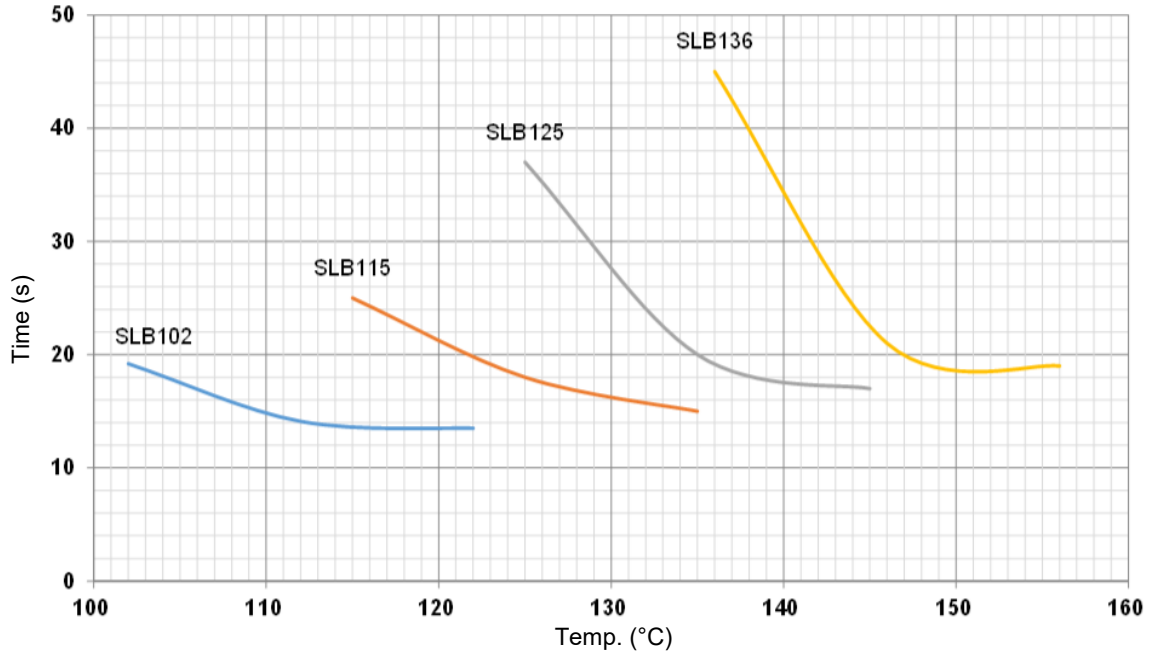

Current-Time Curve

This is an illustrated curve, describing the opening time at Multi-times rated current in the condition of the room Temp. 25 °C (For reference only).

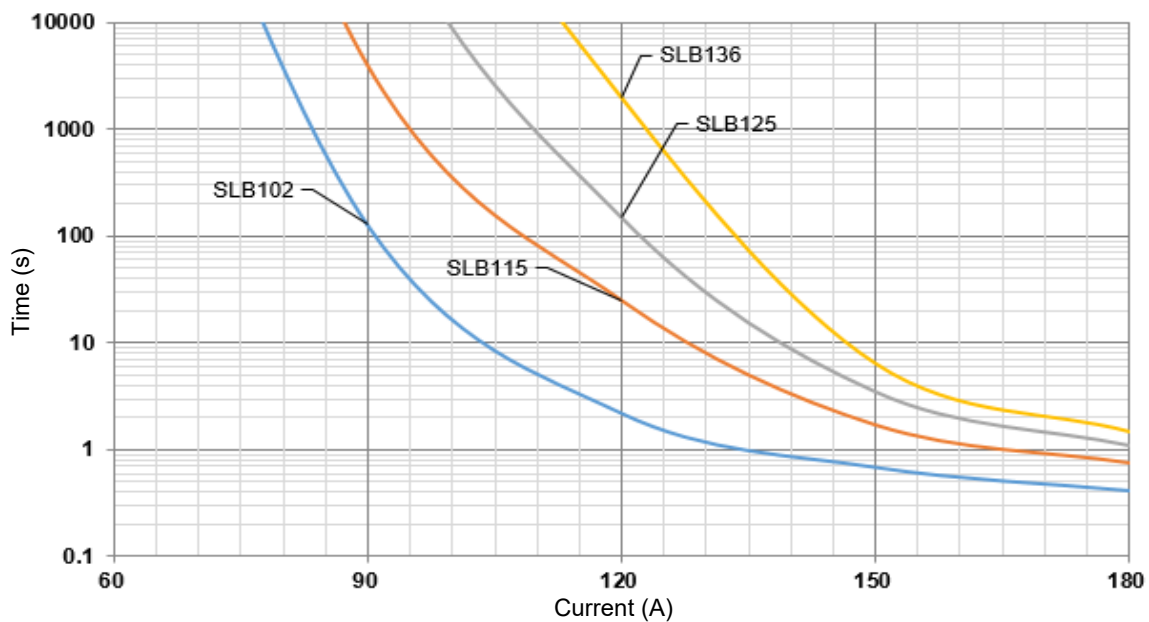

Temp.-Time Curve

The functioning temperature time curve of Alloy Thermal-Link in different Temp. oil bath (For reference only).

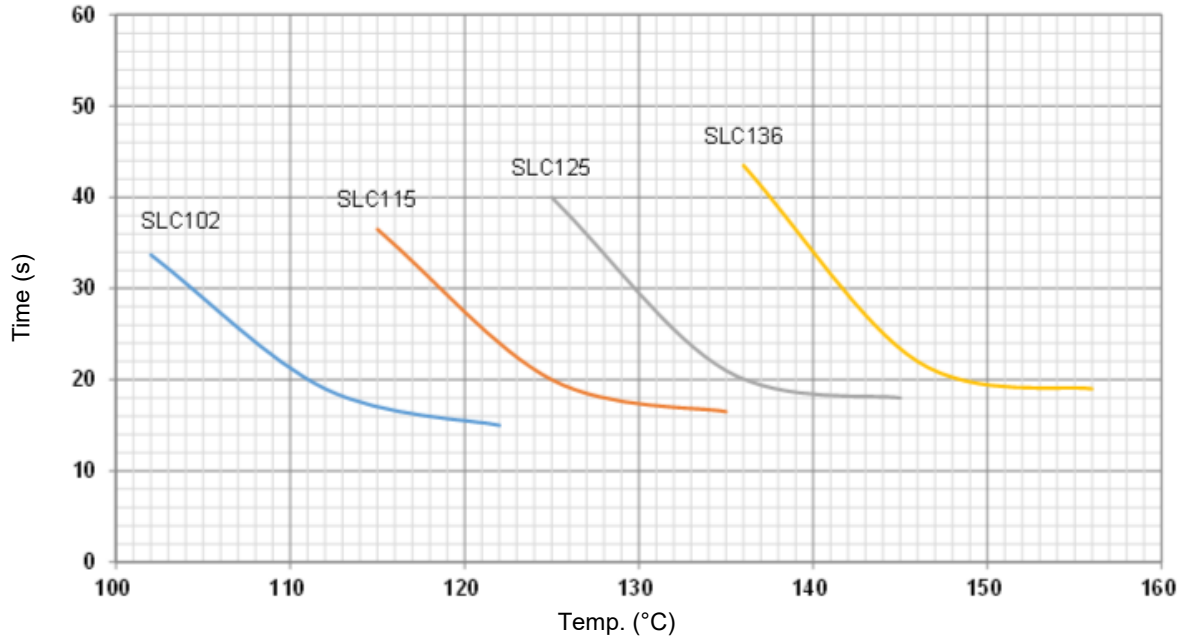

Current-Time Curve

This is an illustrated curve, describing the opening time at Multi-times rated current in the condition of the room Temp. 25 °C (For reference only).

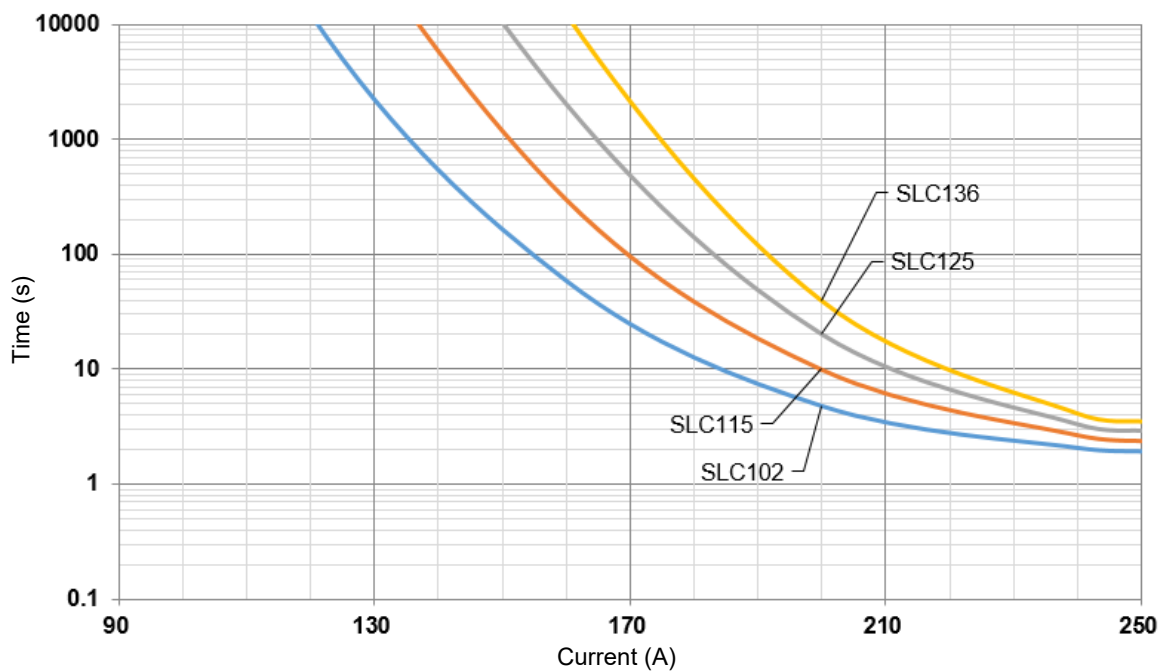

Temp.-Time Curve

The functioning temperature time curve of Alloy Thermal-Link in different Temp. oil bath (For reference only).

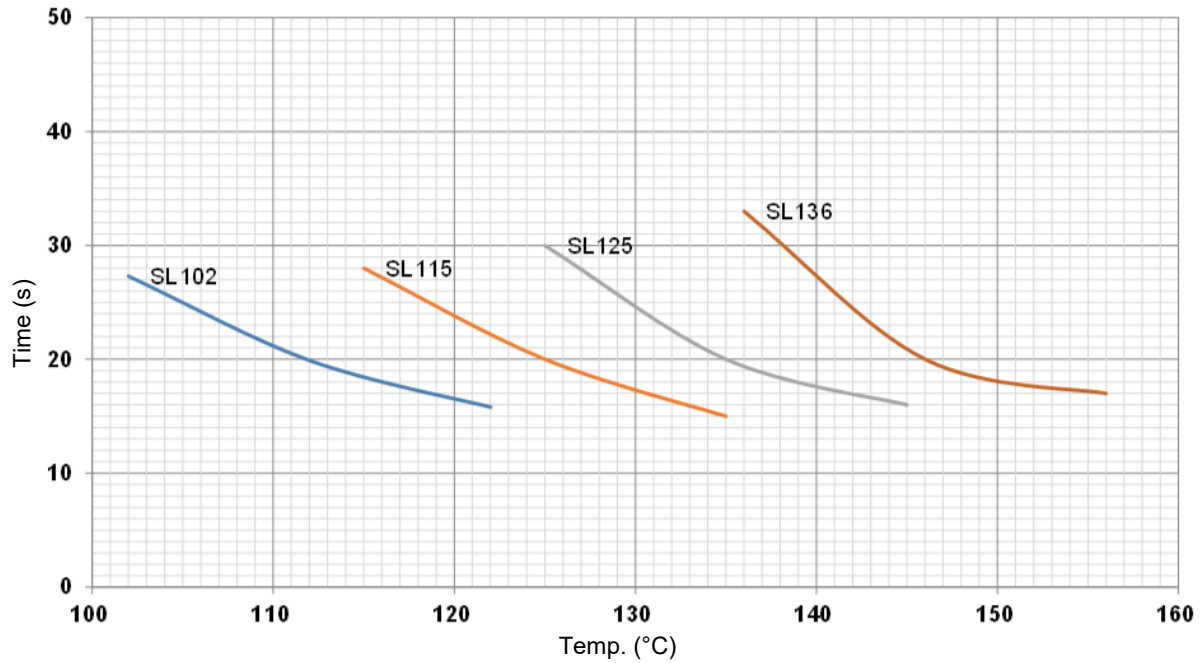

Current-Time Curve

This is an illustrated curve, describing the opening time at Multi-times rated current in the condition of the room Temp. 25 °C (For reference only).

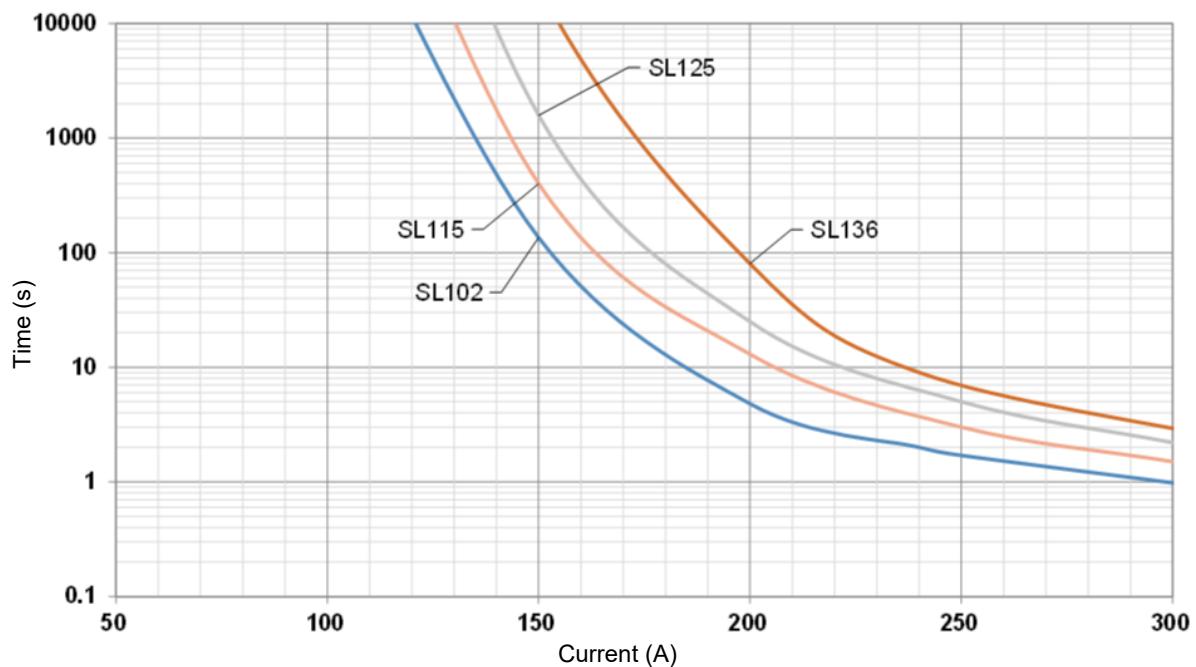

Temp.-Time Curve

The functioning temperature time curve of Alloy Thermal-Link in different Temp. oil bath (For reference only).

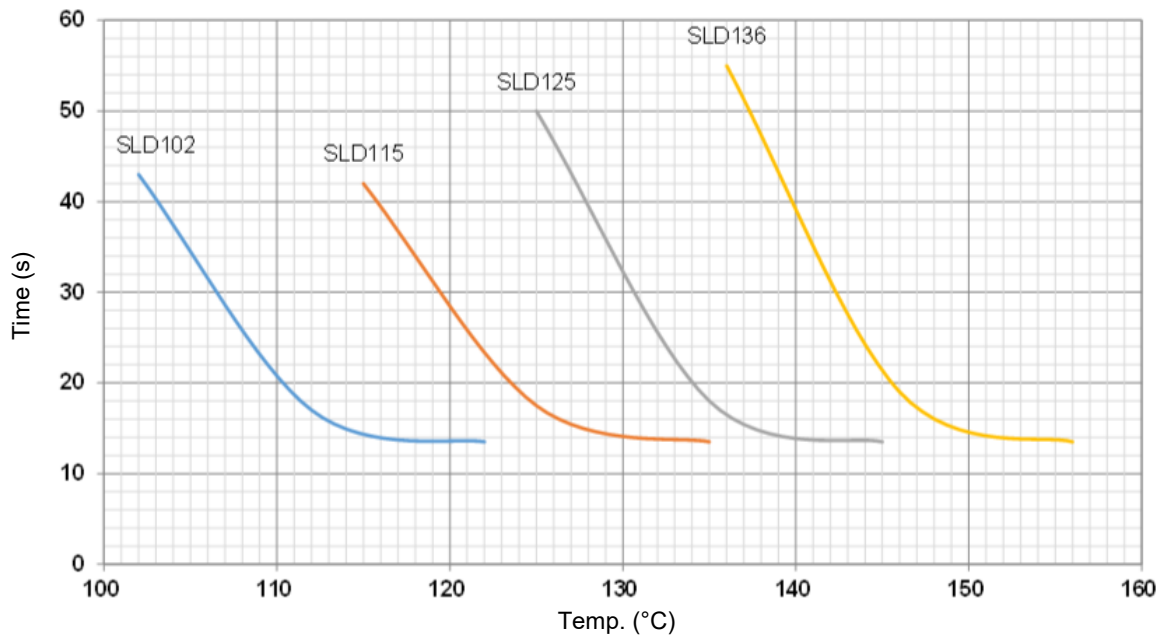

Current-Time Curve

This is an illustrated curve, describing the opening time at Multi-times rated current in the condition of the room Temp. 25 °C (For reference only).

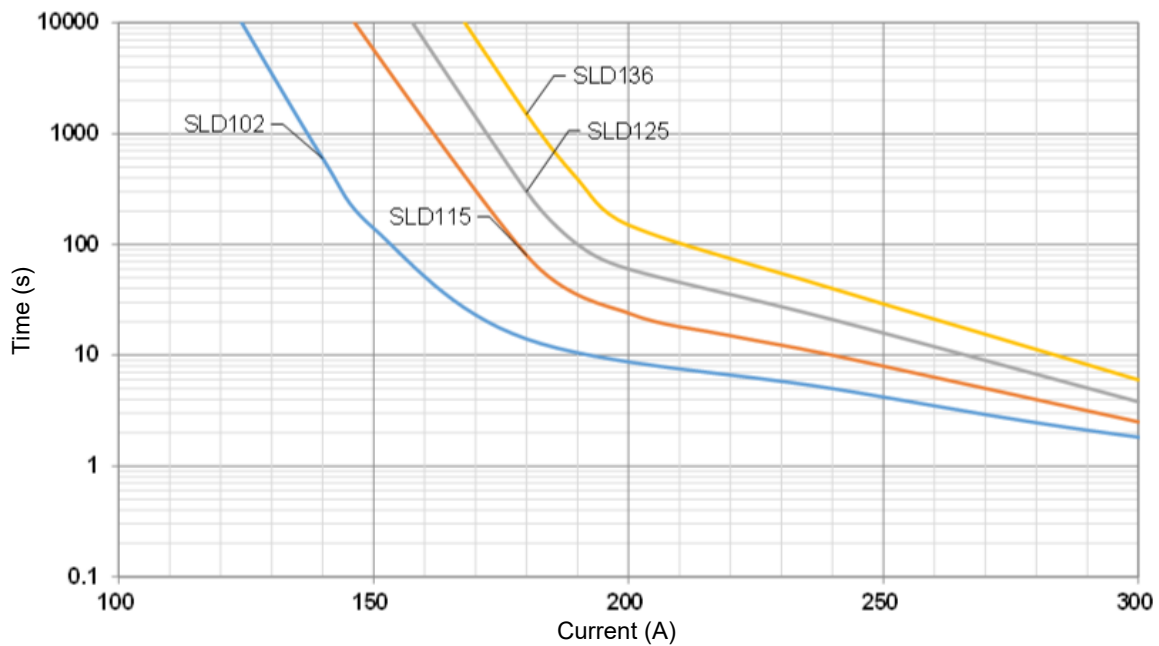

Temp.-Time Curve

The functioning temperature time curve of Alloy Thermal-Link in different Temp. oil bath (For reference only).

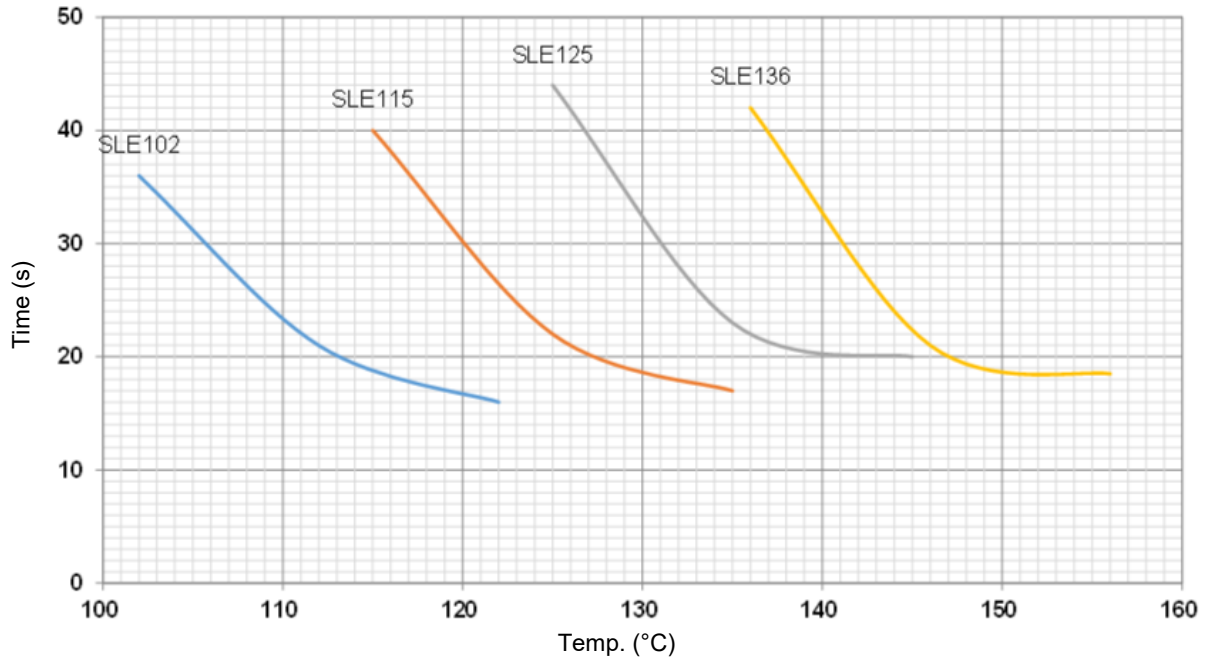

Current-Time Curve

This is an illustrated curve, describing the opening time at Multi-times rated current in the condition of the room Temp. 25 °C (For reference only).

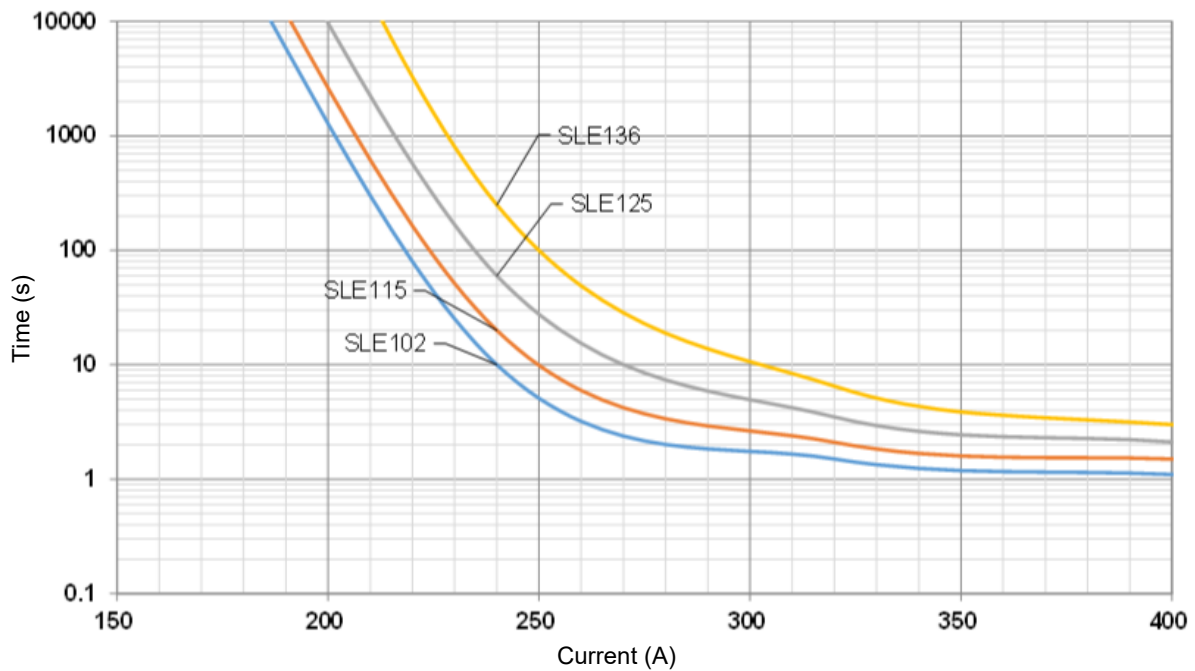

DC-ATCO

Direct Current Thermal-Link (Alloy Type)

SLx Series

Packaging Information

Item	Box	Carton
Dimensions (mm)	145 x 107 x 47	314 x 239 x 160
Quantity (PCS)	40	480
Gross Weight (kg)		3.3 ± 10%

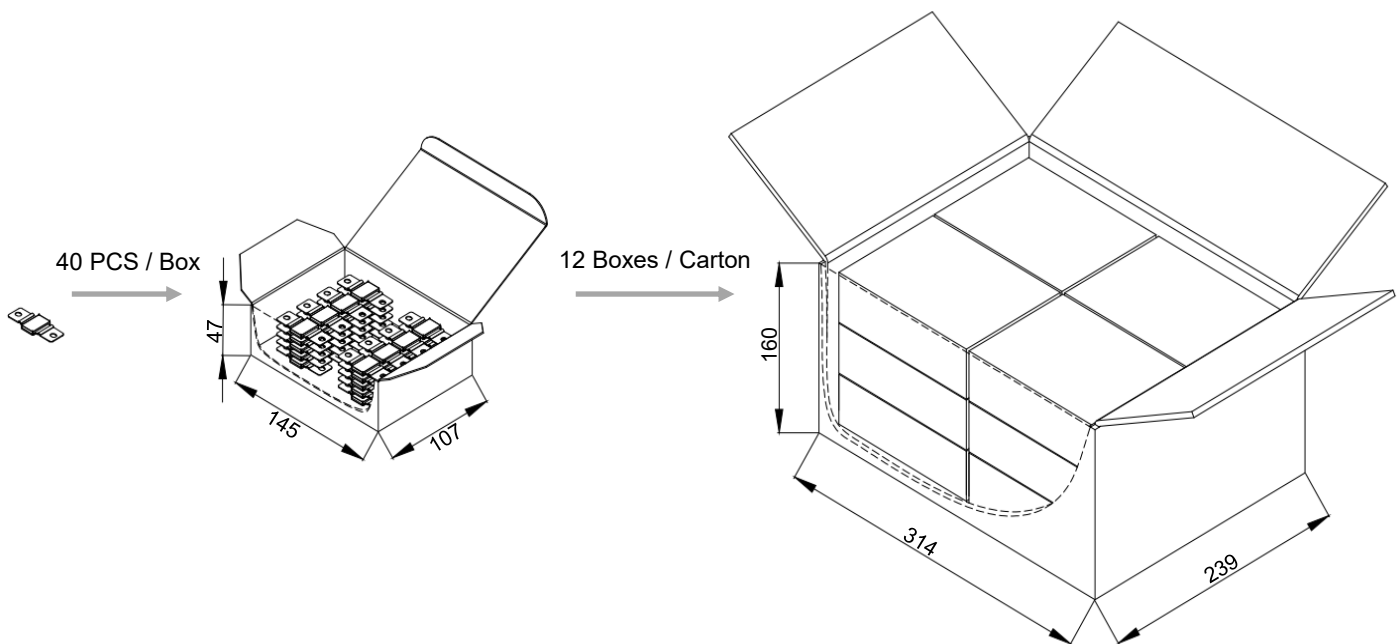

Glossary

Item	Description
DC-ATCO	DC-Alloy Thermal-Link DC-Alloy type Thermal-Link, Alloy is thermal element.
T_f	Rated Functioning Temp. The temperature of the Thermal-Link which causes it to change the state of conductivity with a detection current up to 10 mA as the only load. Tolerance: T_f (0 / -10) °C (GB 9816, EN 60691, K60691). Tolerance: $T_f \pm 7$ °C (J60691).
Fusing Temp.	Fusing Temp. The temperature of the Alloy Thermal-Link which causes it to change its state of conductivity is measured with silicone oil bath in which the temperature is increased at the rate of 0.5 °C to 1 °C / minute, with a detection current up to 10 mA as the only load.
T_h	Holding Temp. The Maximum temperature at which a Thermal-Link will not change its state of conductivity when conducting rated current for 168 hours.
T_m	Maximum Temp. Limit The temperature of the Thermal-Link stated by the manufacturer, up to which the mechanical and electrical properties of the Thermal-Link having changed its state of conductivity, will not be impaired for a given time.
I_{min}	Minimum Breaking Current The minimum current that Fuse requires after the Alloy of Thermal-Link opens in the circuit.
I_r	Rated Current The current used to classify a Thermal-Link, which is the maximum current that Thermal-Link allows to carry and is able to cut off the circuit safely.
U_r	Rated Voltage The voltage used to classify a Thermal-Link, which is the maximum voltage that Thermal-link allows to carry and is able to cut off the circuit safely.



ATTENTION

Usage

1. When atmosphere pressure is from 80 kPa to 106 kPa, the related altitude shall be from -500 m to 2000 m.
2. Operating voltage less than rated voltage of DC-ATCO, operating current less than rated current of DC-ATCO.
3. Do not touch the DC-ATCO body or lead wires directly when power is on, to avoid burn or electric shock.

Replacement

DC-ATCO is a non-repairable product. For safety sake, it shall be replaced by an equivalent DC-ATCO from the same manufacturer, and mounted in the same way.

Storage

Do not store the DC-ATCO at the high temp., high humidity or corrosive gas environment. The product shall be stored at 25 ± 5 °C and $\leq 70\%$ RH, avoid direct sunlight and shall use them up within 1 year after receiving the goods.

Installation

Make Sure the Temp. of Installation Position

1. It is recommended that a dummy DC-ATCO with inbuilt thermo-couple shall be used to determine the proper temp.
2. The terminal product should be tested to ensure that potential abnormal conditions do not cause ambient temp. to exceed the T_m of the DC-ATCO.
3. Mount the DC-ATCO at the location where temp. rises evenly.

Installation position of mechanical performance requirements









1. Ensure that the lead wire is long enough, and avoid actions such as press, tensile or twist.
2. The seal or body of DC-ATCO must not be damaged, burned or over heated.

Mechanical Connection

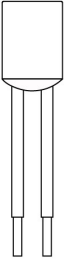

Riveting

1. Choose small resistivity riveting material and be riveted.
2. A flexible lead or lead with low resistance should be used to rivet the DC-ATCO.
3. Contact resistance should be minimal, Large contact resistance will lead to higher temp., DC-ATCO Functioning in advance.

Direct Current Thermal-Link Alloy Type (DC-ATCO) Features & Model List Overview

Rated Functioning Temp. (T _r) °C	Model								
	TGH187-HVS [^]	ASL187A-LSF [^]	RSK187A-KSS [^]	RVH187-HSF [^]	ARL187-LRA [^]			RQF187-FQS [^]	
230	○	○	○	○	○	○	○	○	○
221	○	○	○	○	○	○	○	○	○
205	○	○	○	○	○	○	○	○	○
200	○	○	○	○	○	○	○	○	○
187	TGH187-HVS [^]	ASL187A-LSF [^]	RSK187A-KSS [^]	RVH187-HSF [^]	ARL187-LRA [^]	○	○	RQF187-FQS [^]	○
160	○	○	○	○	○	○	○	○	○
150	TGH150-HVS [^]	ASL150A-LSF [^]	RSK150A-KSS [^]	RVH150-HSF [^]	ARL150-LRA [^]	RPK150-HRZ [^]	TG150C-HQZ [^]	RQF150-FQS [^]	TG150C-JPZ [^]
145	○	○	○	○	○	○	○	○	○
139	○	○	○	○	○	○	○	○	○
136	TGH136-HVS [^]	ASL136A-LSF [^]	RSK136A-KSS [^]	RVH136-HSF [^]	ARL136-LRA [^]	RPK136-HRZ [^]	TG136C-HQZ [^]	RQF136-FQS [^]	TG136C-JPZ [^]
135	○	○	○	○	○	○	○	○	○
133	○	○	○	○	○	○	○	○	○
130	TGH130-HVS [^]	○	○	RVH130-HSF [^]	○	○	○	RQF130-FQS [^]	○
125	TGH125-HVS [^]	ASL125A-LSF [^]	RSK125A-KSS [^]	RVH125-HSF [^]	ARL125-LRA [^]	RPK125-HRZ [^]	TG125C-HQZ [^]	RQF125-FQS [^]	TG125C-JPZ [^]
123	○	○	○	○	○	○	○	○	○
120	○	○	○	○	○	○	○	○	○
115	TGH115-HVS [^]	ASL115A-LSF [^]	RSK115A-KSS [^]	RVH115-HSF [^]	ARL115-LRA [^]	RPK115-HRZ [^]	TG115C-HQZ [^]	RQF115-FQS [^]	TG115C-JPZ [^]
105	○	○	○	○	○	○	○	○	○
102	TGH102-HVS [^]	ASL102A-LSF [^]	RSK102A-KSS [^]	RVH102-HSF [^]	ARL102-LRA [^]	RPK102-HRZ [^]	TG102C-HQZ [^]	RQF102-FQS [^]	TG102C-JPZ [^]
97	○	○	○	○	○	○	○	○	○
93	○	○	○	○	○	○	○	○	○
86	○	○	○	○	ARL86-LRA [^]	○	TG86C-HQZ [^]	RQF86-FQS [^]	○
76	○	○	○	○	○	○	○	○	○
I_r (A) Rated Current	15	30	25	15	30	15	15	10	20
U_r (VDC)[^] Rated Voltage	850		600		500		450		400
U_r (VAC)[*] Rated Voltage	○	○	○	○	○	○	○	○	○
Product Structure									
	Axial Shape		Radial Shape		Axial Shape	Radial Shape	Axial Shape	Radial Shape	Axial Shape

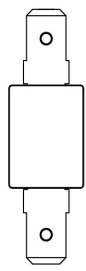
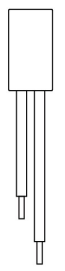
Direct Current Thermal-Link Alloy Type (DC-ATCO) Features & Model List Overview

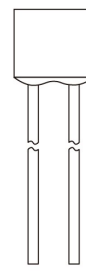
Rated Functioning Temp. (T_r) °C	Model														
	TG150C-JSZ*				HN150^*	HP150^*	HS150^*		QD150^A	PD150^A	TD150^A	SD150^A			
230	○	○	○	○	○	○	○	○	○	○	○	○			
221	○	○	○	○	○	○	○	○	○	○	○	○			
205	○	○	○	○	○	○	○	○	○	○	○	○			
200	○	○	○	○	○	○	○	○	○	○	○	○			
187	○	○	○	○	○	○	○	○	○	○	○	○			
160	○	○	○	○	○	○	○	○	○	○	○	○			
150	TG150C-JSZ*	○	○	○	HN150^*	HP150^*	HS150^*	○	QD150^A	PD150^A	TD150^A	SD150^A			
145	○	○	○	○	○	○	○	○	○	○	○	○			
139	○	○	○	○	○	○	○	○	○	○	○	○			
136	TG136C-JSZ*	○	○	○	HN136^*	HP136^*	HS136^*	○	QD136^A	PD136^A	TD136^A	SD136^A			
135	○	○	○	○	○	○	○	○	○	○	○	○			
133	○	○	○	○	○	○	○	○	○	○	○	○			
130	○	○	○	○	○	○	○	○	QD130^A	PD130^A	TD130^A	SD130^A			
125	TG125C-JSZ*	○	○	○	HN125^*	HP125^*	HS125^*	ALP125-PLZ^A	QD125^A	PD125^A	TD125^A	SD125^A			
123	○	○	○	○	○	○	○	○	○	○	○	○			
120	○	○	○	○	○	○	○	○	○	○	○	○			
115	TG115C-JSZ*	○	○	ALP115-HLZ^A	○	○	○	○	QD115^A	PD115^A	TD115^A	SD115^A			
105	○	○	○	○	○	○	○	○	○	○	○	○			
102	TG102C-JSZ*	○	○	○	○	○	○	ALP102-PLZ^A	QD102^A	PD102^A	TD102^A	SD102^A			
97	○	○	○	○	○	○	○	○	○	○	○	○			
93	○	○	○	○	○	○	○	○	○	○	○	○			
86	○	TG86C-HSZ*	RPF86-FPF^A	○	○	○	○	○	○	○	○	○			
76	○	○	○	○	○	○	○	○	○	○	○	○			
I_r (A) Rated Current															
20 15 10 15 15 10 5 60 20 15/16 10 25															
U_r (VDC)^A Rated Voltage															
○ 400 200 180 125															
U_r (VAC)^* Rated Voltage															
600 ○															
Product Structure															
															
Axial Shape				Radial Shape				Axial Shape				Radial Shape			

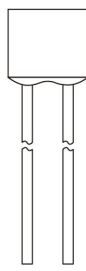
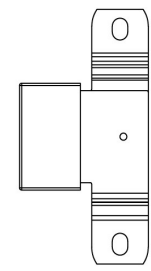
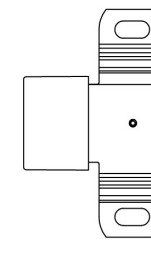
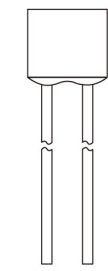
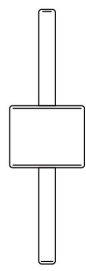

Direct Current Thermal-Link Alloy Type (DC-ATCO) Features & Model List Overview

Rated Functioning Temp. (T _r) °C	Model													
	Q136**	Q136*	Q136*	P136**	P136*	P136*	TB136-UHZ^	TB136-UJZ*	TS136-RHZ^	TS136-RJZ*	S136^	T136^	ADN230B-NEZ	
230	○	○	○	○	○	○	○	○	○	○	○	○	○	○
221	○	○	○	○	○	○	○	○	○	○	○	○	○	○
205	○	○	○	○	○	○	○	○	○	○	○	○	○	○
200	○	○	○	○	○	○	○	○	○	○	○	○	○	○
187	○	○	○	○	○	○	○	○	○	○	○	○	○	○
160	○	○	○	○	○	○	○	○	○	○	○	○	○	○
150	○	○	○	○	○	○	○	○	○	○	S150^	T150^	○	○
145	○	○	○	○	○	○	○	○	○	○	○	○	○	○
139	○	○	○	○	○	○	○	○	○	○	○	○	○	○
136	○	○	○	○	○	○	○	○	○	○	○	○	○	○
135	○	○	○	○	○	○	○	○	○	○	○	○	○	○
133	○	○	○	○	○	○	○	○	○	○	○	○	○	○
130	○	○	○	○	○	○	○	○	○	○	○	○	○	○
125	○	○	○	○	○	○	○	○	○	○	○	○	○	○
125	Q125**	○	○	P125**	○	○	TB125-UHZ^	TB125-UJZ*	TS125-RHZ^	TS125-RJZ*	○	○	○	○
123	○	○	○	○	○	○	○	○	○	○	○	○	○	○
120	○	○	○	○	○	○	○	○	○	○	○	○	○	○
115	Q115**	Q115*	Q115*	P115**	P115*	P115*	TB115-UHZ^	TB115-UJZ*	TS115-RHZ^	TS115-RJZ*	S115^	T115^	○	○
105	○	○	○	○	○	○	○	○	○	○	○	○	○	○
102	Q102**	○	○	P102**	P102*	P102*	TB102-UHZ^	TB102-UJZ*	TS102-RHZ^	TS102-RJZ*	S102^	T102^	○	○
97	○	○	○	○	○	○	○	○	○	○	○	○	○	○
93	○	○	○	○	○	○	○	○	○	○	○	○	○	○
86	○	○	○	○	○	○	○	○	○	○	○	○	○	○
76	○	○	○	○	○	○	○	○	○	○	○	○	○	○
I_r (A) Rated Current	25			20			200		100		10	15 16	50	
U_r (VDC)^ Rated Voltage	120						100	○	100	○	100	60		
U_r (VAC)* Rated Voltage	400	300	250	400	300	250	○	125	○	125	○	○		
Product Structure														
							Radial Shape						Axial Shape	

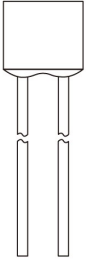
Direct Current Thermal-Link Alloy Type (DC-ATCO) Features & Model List Overview

Rated Functioning Temp. (T _r) °C	Model																						
	R31 ^{Λ*}	U31 ^{Λ*}						C31 ^{Λ*}				B31 ^{Λ*}	H31 ^{Λ*}	V31 ^{Λ*}	V31*		X31*	K31*					
230	○	○	○	○	○	○	○	○	○	○	○	○	○	○	○	○	○	○	○	○			
221	R31 ^{Λ*}	○	U31 ^{Λ*}	○	○	○	○	○	C31 ^{Λ*}	○	○	○	○	B31 ^{Λ*}	○	H31 ^{Λ*}	V31 ^{Λ*}	V31*	○	○	X31*	K31*	○
205	R32 ^{Λ*}	○	U32 ^{Λ*}	○	○	○	○	○	C32 ^{Λ*}	○	○	○	○	B32 ^{Λ*}	○	H32 ^{Λ*}	V32 ^{Λ*}	V32*	○	○	X32*	K32*	○
200	○	○	○	○	○	○	○	○	○	○	○	○	○	○	○	○	○	○	○	○	○	○	○
187	○	○	○	○	○	○	○	○	○	○	○	○	○	○	○	○	○	○	○	○	X17 ^{Λ*}	K17 ^{Λ*}	○
160	R16 ^{Λ*}	○	U16 ^{Λ*}	○	○	○	○	○	C16 ^{Λ*}	○	○	○	○	○	H16 ^{Λ*}	V16 ^{Λ*}	○	○	○	○	X16 ^{Λ*}	K16 ^{Λ*}	F16*
150	R7 ^{Λ*}	○	U7 ^{Λ*}	○	○	○	○	○	○	○	○	○	○	○	○	○	○	○	○	○	X7*	K7*	F7*
145	R6 ^{Λ*}	○	U6 ^{Λ*}	C6 ^Λ	○	○	○	○	○	○	X6 ^Λ	○	○	○	○	○	K6 ^Λ	F6 ^Λ	X6*	K6*	F6*		
139	○	CR13 ^Λ	○	○	M13 ^Λ	C13 ^Λ	○	○	○	SF13 ^Λ	V13 ^Λ	○	○	○	○	○	○	F13 ^Λ	○	○	○	F13*	
136	○	○	○	○	○	○	○	○	○	○	X9 ^Λ	○	○	○	○	○	K9 ^Λ	○	X9*	K9*	○		
135	R5 ^{Λ*}	○	U5 ^{Λ*}	○	○	○	○	○	○	○	○	○	○	○	○	○	○	○	○	X5*	K5*	○	
133	○	○	○	○	○	○	○	○	○	○	V8 ^Λ	SF8 ^Λ	○	○	○	○	○	F8 ^Λ	X8*	K8*	F8*		
130	R4 ^{Λ*}	○	U4 ^{Λ*}	○	○	○	○	○	○	○	V4 ^Λ	SF4 ^Λ	○	○	○	○	○	F4 ^Λ	X4*	K4*	F4*		
125	R3 ^{Λ*}	○	U3 ^{Λ*}	○	○	○	○	○	○	○	○	○	○	H3 ^{Λ*}	○	○	○	○	X3 ^{Λ*}	K3 ^{Λ*}	F3*		
123	○	○	○	○	○	○	○	○	○	○	○	○	○	○	○	○	○	○	○	○	○	○	○
120	○	○	○	○	○	○	○	○	○	○	○	○	○	○	○	○	○	○	○	○	○	○	○
115	R2 ^{Λ*}	○	U2 ^{Λ*}	○	○	○	C2 ^Λ	○	○	○	V2 ^Λ	SF2 ^Λ	○	○	○	○	○	F2 ^Λ	X2 ^{Λ*}	K2 ^{Λ*}	F2*		
105	○	○	○	○	○	○	○	○	○	○	○	○	○	○	○	○	○	○	○	○	○	○	○
102	R1 ^{Λ*}	○	U1 ^{Λ*}	○	○	○	○	○	○	○	○	○	○	○	○	○	○	F1 ^Λ	X1 ^{Λ*}	K1 ^{Λ*}	F1*		
97	○	○	○	○	○	○	○	○	○	○	○	○	○	○	○	○	○	○	○	○	○	○	○
93	○	○	○	○	○	○	○	○	○	○	○	○	○	○	○	○	○	○	○	○	○	○	○
86	R18 ^{Λ*}	○	U18 ^{Λ*}	○	○	○	○	C18 ^Λ	○	○	○	○	○	V18 ^Λ	○	○	○	○	F18 ^Λ	X18 ^{Λ*}	K18 ^{Λ*}	F18*	
76	R0 ^{Λ*}	○	U0 ^{Λ*}	○	○	○	○	○	○	○	○	○	○	○	○	○	○	○	X0*	K0*	F0*		
I_r (A) Rated Current		15	10	9	8.5	8	6	5	4	3	2.5	2	1	4	3	2	1						
U_r (VDC)^Λ Rated Voltage		60																					
U_r (VAC)[*] Rated Voltage		250	○	250	○	250			○	250	○	250	125	○	250								
Product Structure		 <p>Axial Shape</p>										 <p>Radial Shape</p>											

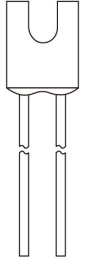
Direct Current Thermal-Link Alloy Type (DC-ATCO) Features & Model List Overview

Rated Functioning Temp. (T _r) °C	Model										Model				
	XG31*	KG31*			C31*		B31*		H31*		ADN230B-NDZ ^Δ	ADN230B-PDZ ^Δ		ADN230B-QBZ ^Δ	
230	○	○	○	○	○	○	○	○	○	○	○	○	○	○	
221	XG31*	KG31*	○	○	C31*	○	B31*	○	H31*	○	○	○	ADN205B-NDZ ^Δ	○	
205	XG32*	KG32*	○	○	C33*	○	B32*	○	H32*	○	○	○	○	○	
200	○	○	○	○	○	○	○	○	○	○	○	○	○	○	
187	○	○	○	○	○	○	○	○	○	○	○	○	○	○	
160	XG16*	KG16*	○	○	○	B16*	○	○	○	○	○	○	○	○	
150	XG7*	KG7*	C7 ^Δ	C7*	○	B7 ^Δ	○	H7 ^Δ	○	V7 ^Δ	○	○	○	○	
145	XG6*	KG6*	C6 ^Δ	C6*	○	B6 ^Δ	○	H6 ^Δ	○	V6 ^Δ	○	○	○	○	
139	○	○	C13 ^Δ	C13*	○	B13 ^Δ	○	H13 ^Δ	○	V13 ^Δ	○	○	○	○	
136	XG9*	KG9*	C9 ^Δ	C9*	○	B9 ^Δ	○	H9 ^Δ	○	V9 ^Δ	○	○	○	○	
135	XG5*	KG5*	C5 ^Δ	C5*	○	B5 ^Δ	○	H5 ^Δ	○	V5 ^Δ	○	○	○	○	
133	XG8*	KG8*	C8 ^Δ	C8*	○	B8 ^Δ	○	H8 ^Δ	○	V8 ^Δ	○	○	○	○	
130	XG4*	KG4*	C4 ^Δ	C4*	○	B4 ^Δ	○	H4 ^Δ	○	V4 ^Δ	○	○	○	○	
125	XG3 ^Δ *	KG3 ^Δ *	C3 ^Δ	C3*	○	B3 ^Δ *	○	○	○	V3 ^Δ *	○	○	○	○	
123	○	○	○	○	○	○	○	○	○	○	○	○	○	○	
120	○	○	○	○	○	○	○	○	○	○	○	○	○	○	
115	XG2 ^Δ *	KG2 ^Δ *	C2 ^Δ	C2*	○	B2 ^Δ *	○	H2 ^Δ *	○	V2 ^Δ *	○	○	○	○	
105	○	○	○	○	○	○	○	○	○	○	○	○	○	○	
102	XG1 ^Δ *	KG1 ^Δ *	○	C1 ^Δ *	C1*	B1 ^Δ *	B1*	H1 ^Δ *	H1*	V1 ^Δ *	V1*	○	○	○	
97	○	○	○	○	C21 ^Δ *	○	B21 ^Δ *	○	H21 ^Δ *	○	V21 ^Δ *	○	○	○	
93	○	○	○	○	○	○	○	○	○	○	○	○	○	○	
86	XG18 ^Δ *	KG18 ^Δ *	○	C18 ^Δ *	C18*	B18 ^Δ *	B18*	H18 ^Δ *	H18*	V18 ^Δ *	V18*	○	○	○	
76	XG0*	KG0*	○	C0*	○	B0 ^Δ *	B0*	H0 ^Δ *	H0*	V0 ^Δ *	V0*	○	○	○	
I_r (A) Rated Current	3	2	7	5	3	2	1	50	55	50	80				
U_r (VDC)^Δ Rated Voltage	60		50								49	48	24		
U_r (VAC)[*] Rated Voltage	250		○	250	125	250	125	250	125	250	125	○			
Product Structure	 <p>Radial Shape</p>				 <p>Axial Shape</p>						